

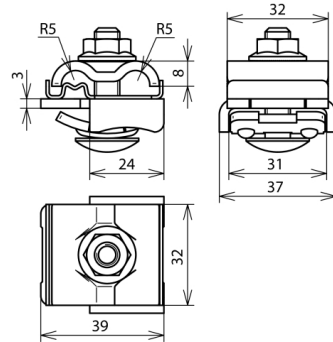

UNI FK 8.10 KBF0.7 8 AL V2A (365 250)



Figure without obligation



For integrating mounting systems, e.g. of PV installations, in the functional equipotential bonding / functional earthing (black conductor possible) and lightning equipotential bonding according to IEC/EN 62305-3.

The StSt contact plate (intermediate element) allows different conductor materials (Cu, Al, St/tZn and StSt) to be connected to the normal mounting systems, e.g. to aluminium, without the risk of contact corrosion.

The double clamp design allows easy and quick interconnection of the profiles, e.g. by feed-through wiring.



Arrangement:

Type	UNI FK 8.10 KBF0.7 8 AL V2A
Part No.	365 250
Clamping range of saddle	0.7-8 mm
Material of clamping bracket	Al
Material thickness	3 mm
Clamping range Rd	8-10 mm
Connection (solid / stranded)	4-50 mm ²
Material of double clamp	StSt
Screw	⬆ M8 x 35 mm
Self-locking nut	width across flats 13 mm
Material of screw / nut	StSt
Connecting direction	lengthwise / crosswise
Lightning current carrying capability (10/350 µs)	⚡ 50 kA *)
Standard	EN 62561-1
Weight	83 g
Customs tariff number (Comb. Nomenclature EU)	85359000
GTIN	4013364148307
PU	50 pc(s)

*) See test certificate for exact classification.

We reserve the right to introduce changes in performance, configuration and technology, dimensions, weights and materials in the course of technical progress. The figures are shown without obligation.